

TAU system gelijmd / TAU adhesive system

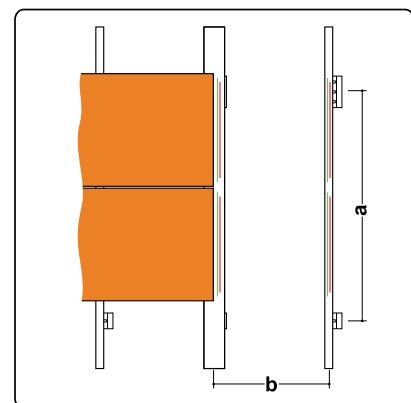

TAU
systeem gelijmd
adhesive system

GEVELAANZICHT

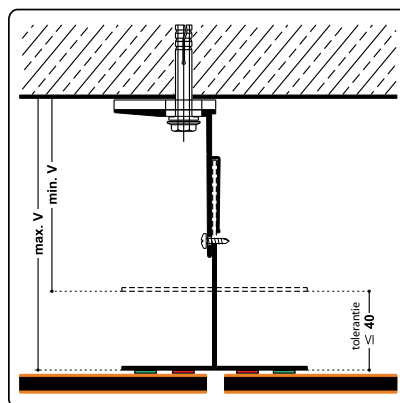
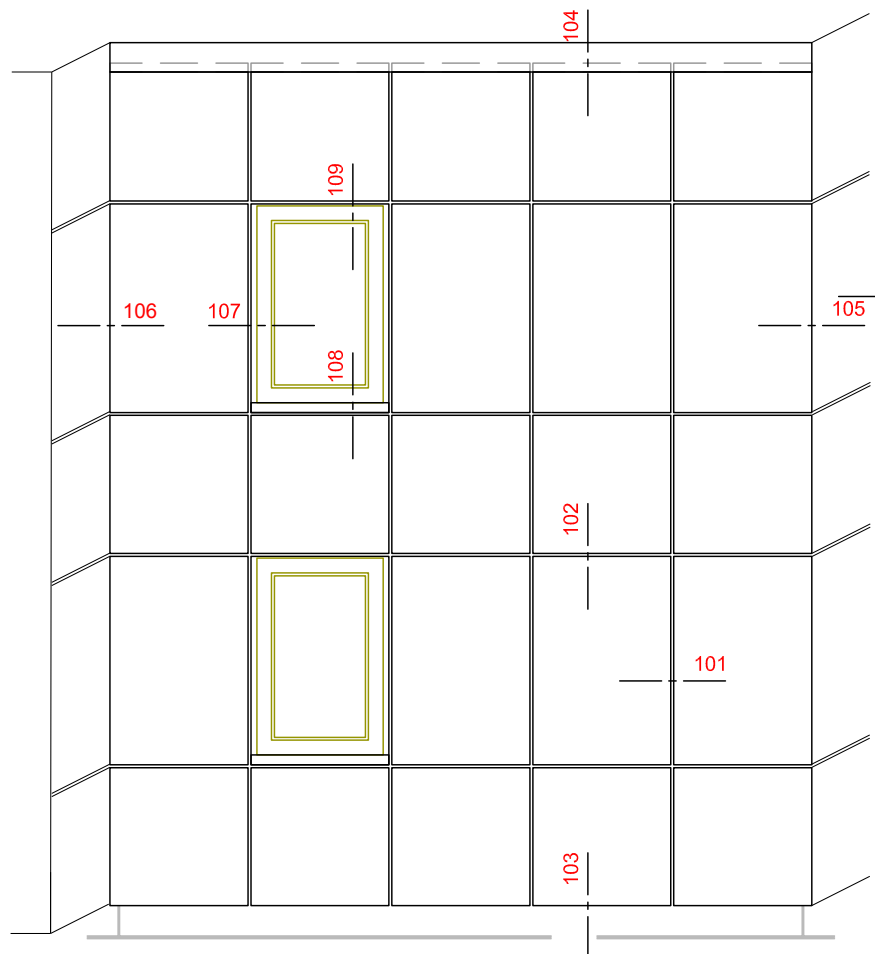

TAU
systeem gelijmd
adhesive system

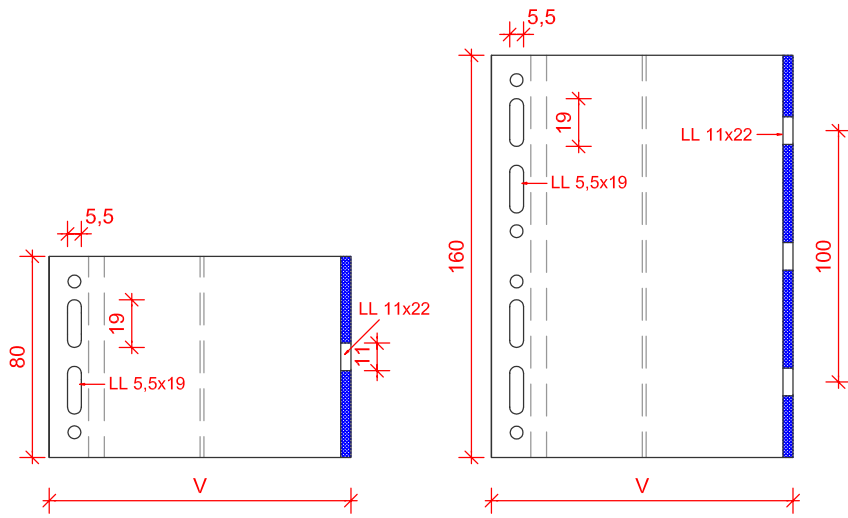

Medium M h=80

Large L h=160

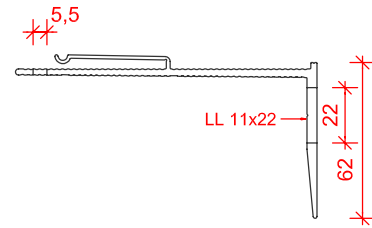
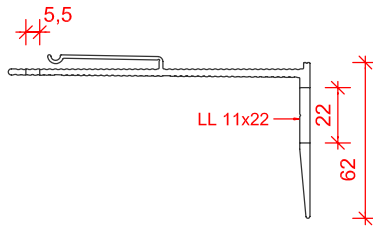

Alucopal® Bevestigingselementen / brackets								
V (mm)	40	60	90	120	150	180	210	240

M 1:2

TAU
systeem gelijmd
adhesive system

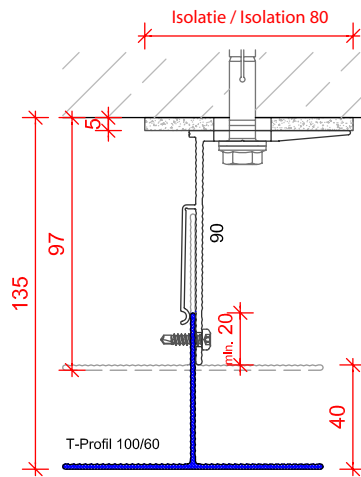

M 1:2

Alucopal® Bevestigingselementen / brackets		
Afstand tot de achterconstructie distance to the wall (mm)		
V	van / from	tot / to
40 *	47,5	65
60	67	105
90 *	97	135
120	127	165
150	157	195
180	187	225
210 *	217	255
240	247	285

* zie detail / see detail

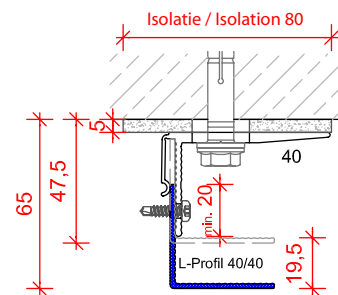
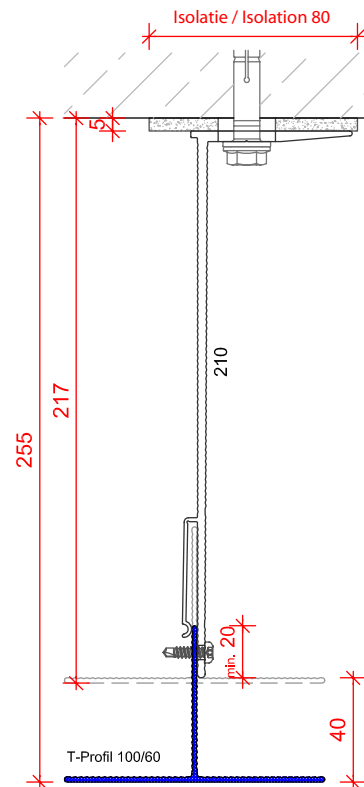

TAU
systeem gelijmd
adhesive system

DETAIL 101

Verticale voegaansluiting
Vertical joint connection

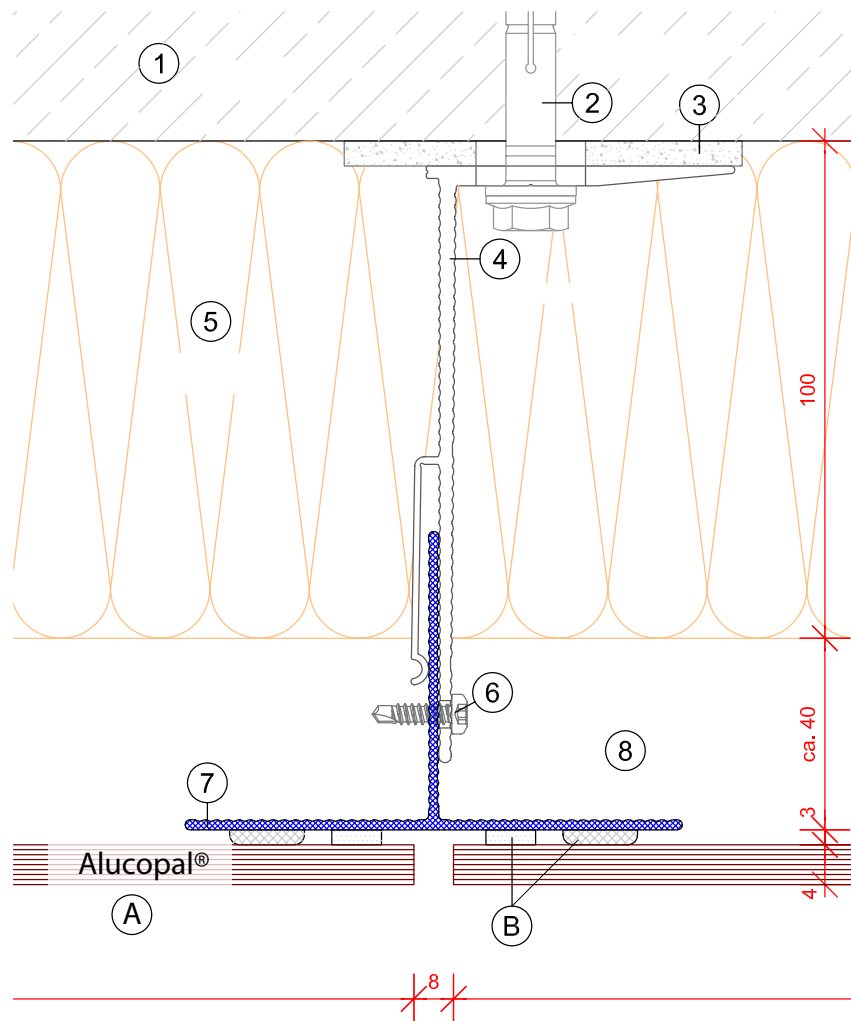

1. Wand / Wall
2. Plug / Dowel
3. Isolator / Isolator
4. Steun 120 / Bracket 120
5. Isolatie / Isolation
6. Zelfsnijdende schroef / self drilling screw
6A. Blindklinknagel / Rivet
7. T-profiel / T-profile
7A. L-profiel / L-profile
8. Ventilatie / Ventilation
A. Alucopal®
B. Plastiflex® lijmbevestigingssysteem / Plastiflex® adhesive system

TAU
systeem gelijmd
adhesive system

DETAIL 102

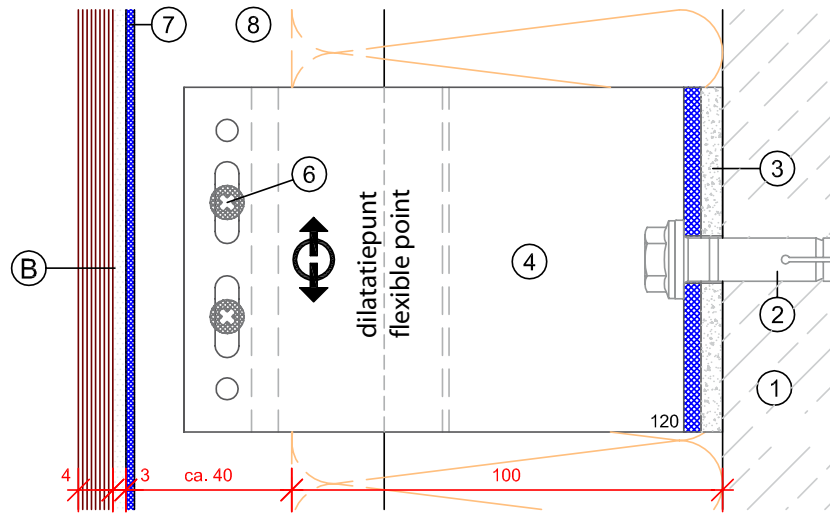

Horizontale voegaansluiting
Horizontal seam connection

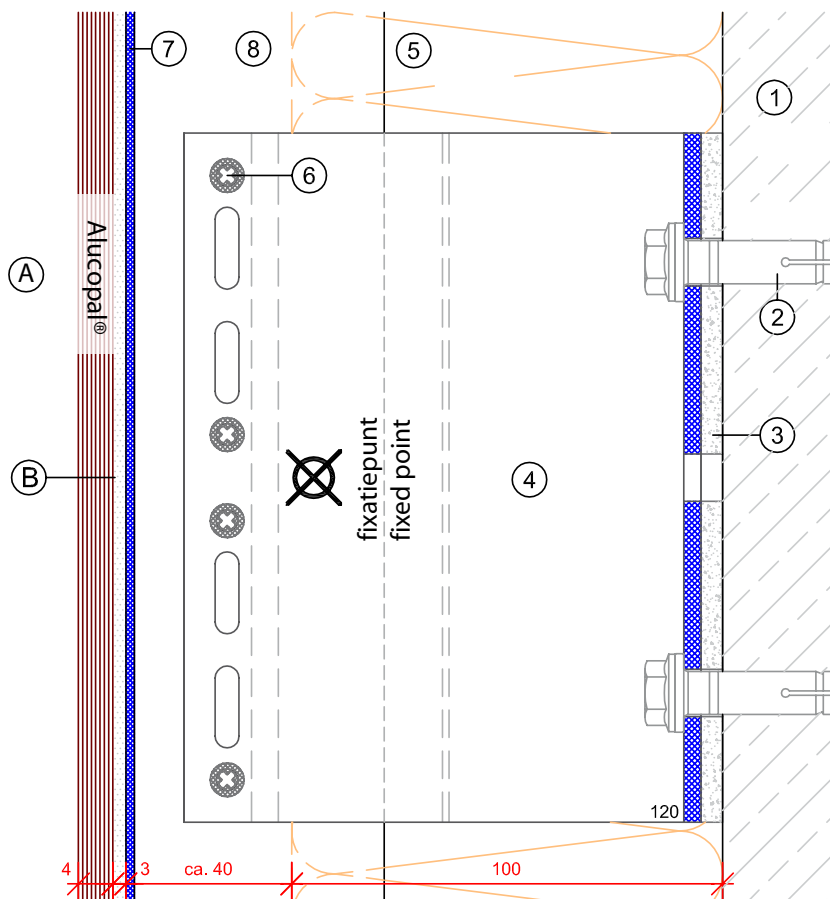

1. Wand / Wall
2. Plug / Dowel
3. Isolator / Isolator
4. Steun 120 / Bracket 120
5. Isolatie / Isolation
6. Zelfsnijdende schroef / self drilling screw
6A. Blindklinknagel / Rivet
7. T-profiel / T-profile
7A. L-profiel / L-profile
8. Ventilatie / Ventilation
A. Alucopal®
B. Plastiflex® lijmbevestigingssysteem / Plastiflex® adhesive system

TAU
systeem gelijmd
adhesive system

DETAIL 103

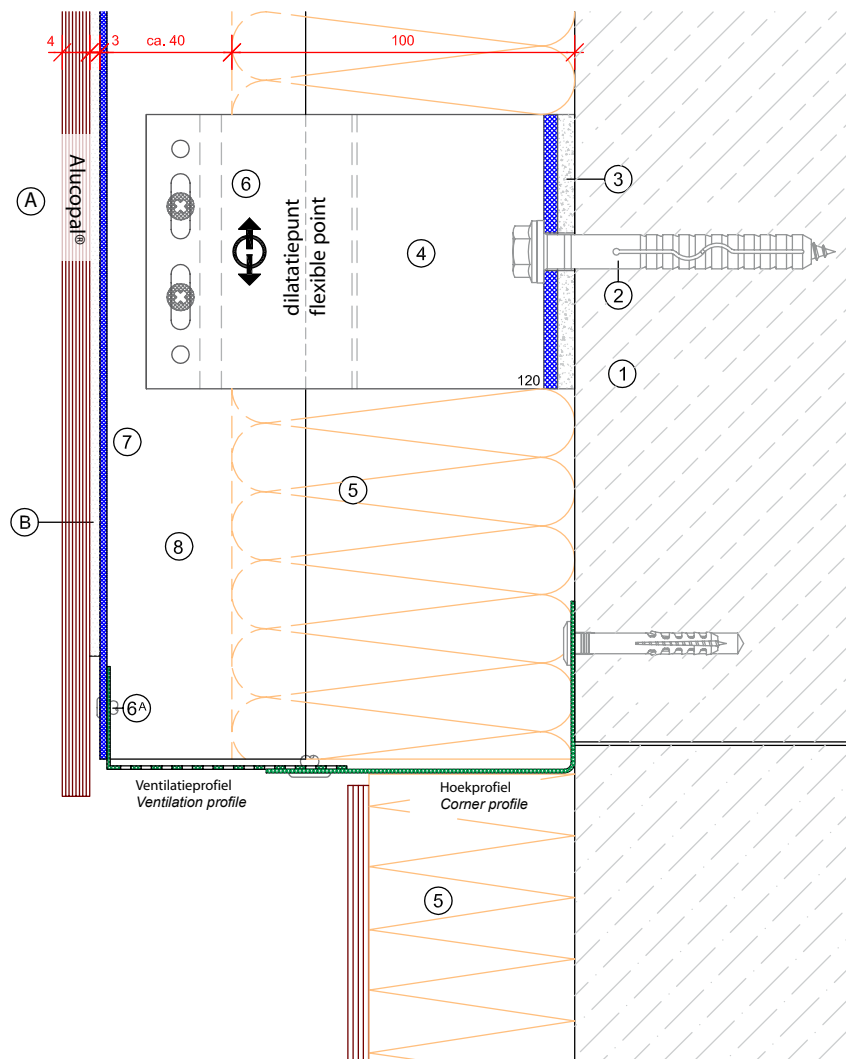

Gevelaansluiting
Façade connection

1. Wand / Wall
2. Plug / Dowel
3. Isolator / Isolator
4. Steun 120 / Bracket 120
5. Isolatie / Isolation
6. Zelfsnijdende schroef / self drilling screw
6A. Blindklinknagel / Rivet
7. T-profiel / T-profile
7A. L-profiel / L-profile
8. Ventilatie / Ventilation
A. Alucopal®
B. Plastiflex® lijmbevestigingssysteem / Plastiflex® adhesive system

TAU
systeem gelijmd
adhesive system

DETAIL 104

Dakaansluiting
Roof connection

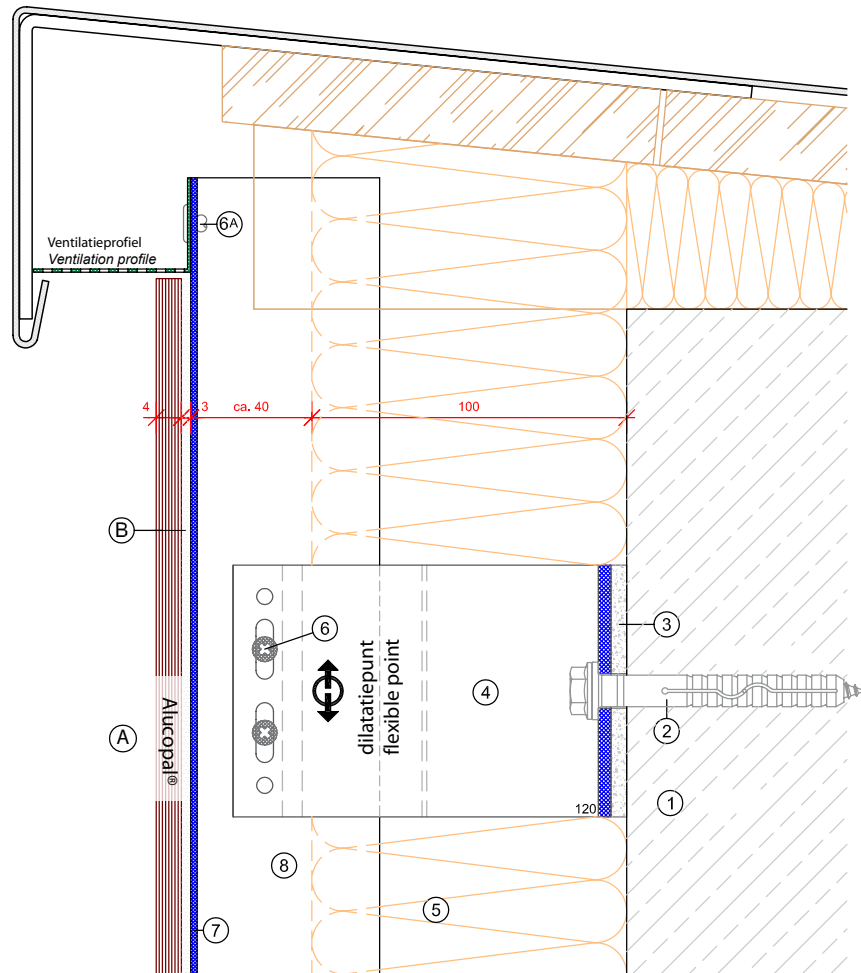

1. Wand / Wall
2. Plug / Dowel
3. Isolator / Isolator
4. Steun 120 / Bracket 120
5. Isolatie / Isolation
6. Zelfsnijdende schroef / self drilling screw
6A. Blindklinknagel / Rivet
7. T-profiel / T-profile
7A. L-profiel / L-profile
8. Ventilatie / Ventilation
A. Alucopal®
B. Plastiflex® lijmbevestigingssysteem / Plastiflex® adhesive system

TAU
systeem gelijmd
adhesive system

DETAIL 105

Buitenhoek
Outside corner

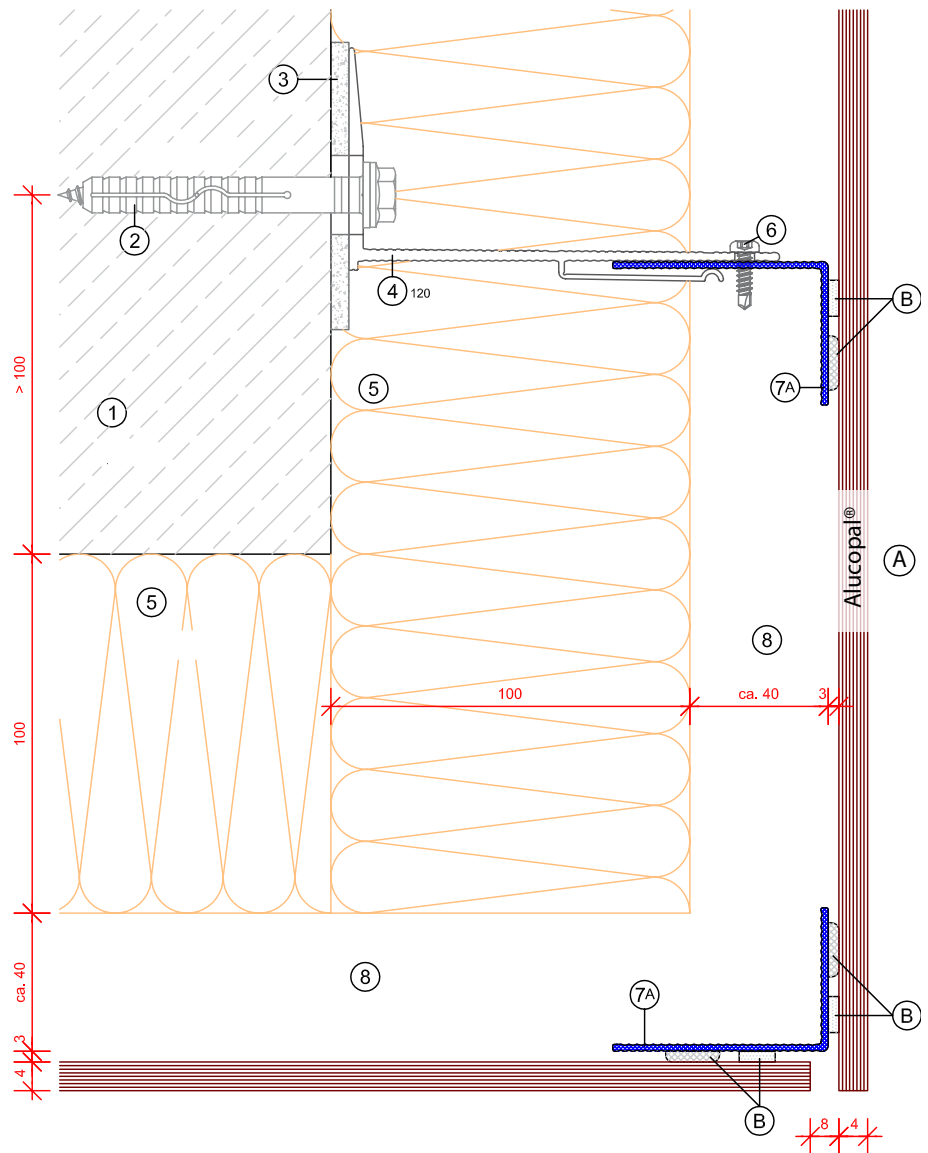

1. Wand / Wall
2. Plug / Dowel
3. Isolator / Isolator
4. Steun 120 / Bracket 120
5. Isolatie / Isolation
6. Zelfsnijdende schroef / self drilling screw
6A. Blindklinknagel / Rivet
7. T-profiel / T-profile
7A. L-profiel / L-profile
8. Ventilatie / Ventilation
A. Alucopal®
B. Plastiflex® lijmbevestigingssysteem / Plastiflex® adhesive system

TAU
systeem gelijmd
adhesive system

DETAIL 106

Binnenhoek
Inside corner

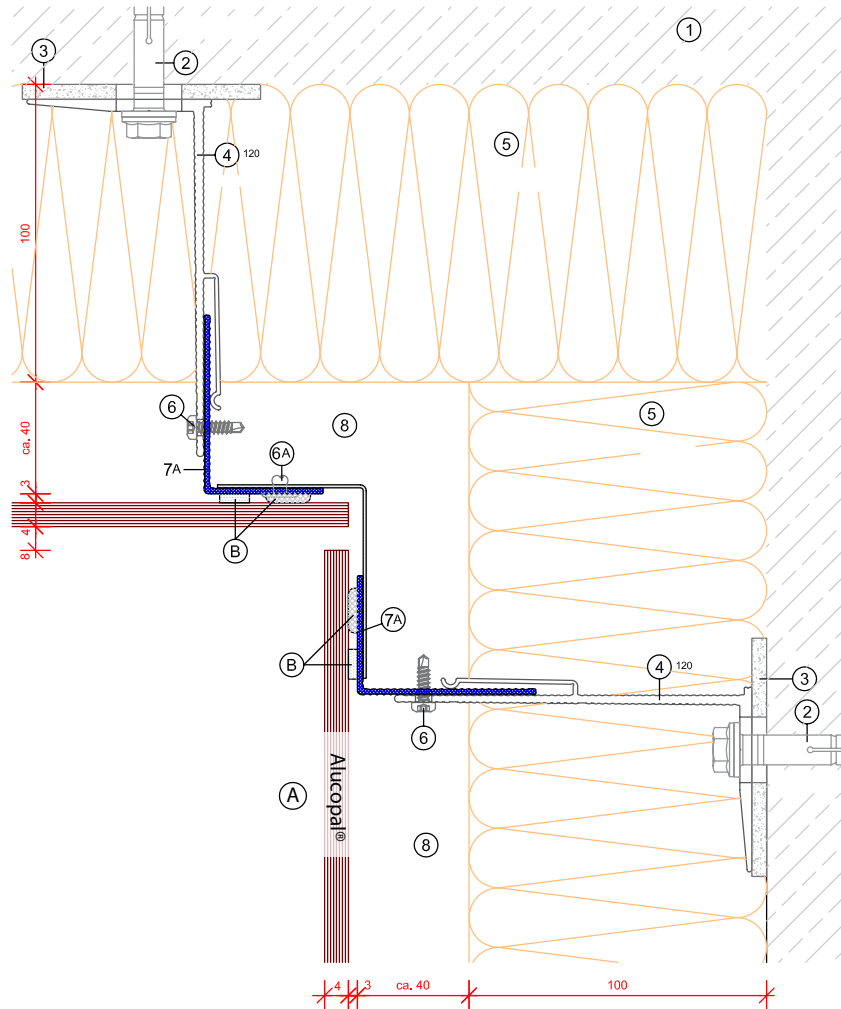

1. Wand / Wall
2. Plug / Dowel
3. Isolator / Isolator
4. Steun 120 / Bracket 120
5. Isolatie / Isolation
6. Zelfslijdende schroef / self drilling screw
6A. Blindklinknagel / Rivet
7. T-profiel / T-profile
7A. L-profiel / L-profile
8. Ventilatie / Ventilation
A. Alucopal®
B. Plastiflex® lijmbevestigingssysteem / Plastiflex® adhesive system

TAU
systeem gelijmd
adhesive system

DETAIL 107

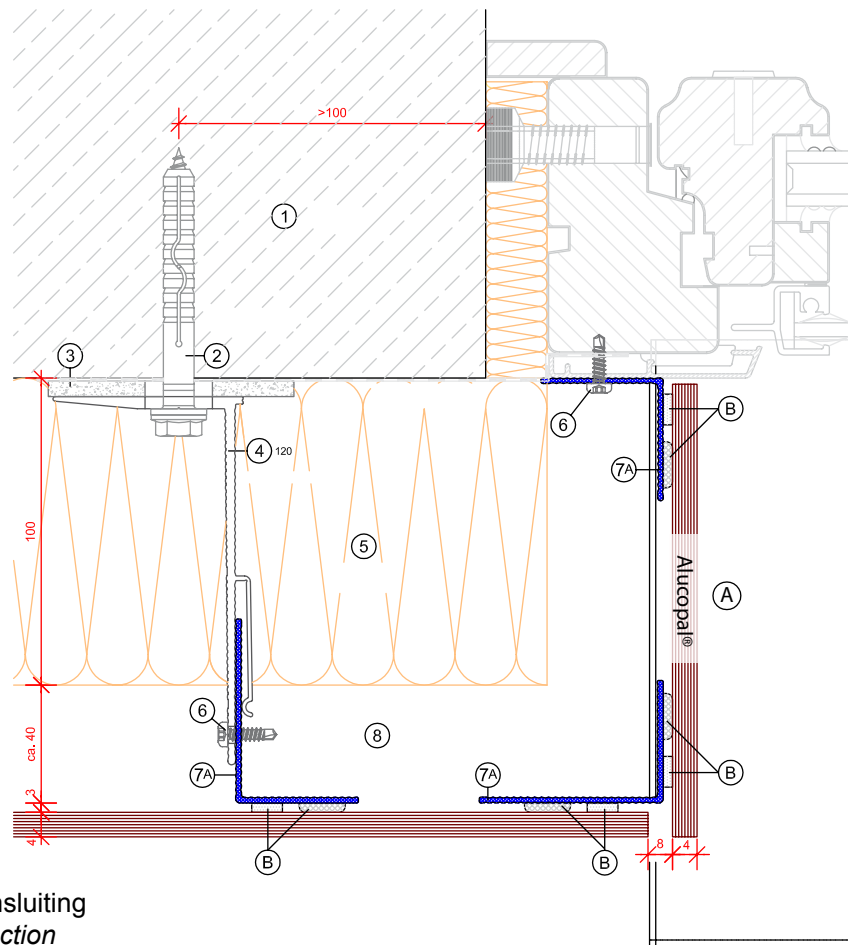

Verticale doorsnede raamaansluiting
Vertical profile window connection

1. Wand / Wall
2. Plug / Dowel
3. Isolator / Isolator
4. Steun 120 / Bracket 120
5. Isolatie / Isolation
6. Zelfsnijdende schroef / self drilling screw
6A. Blindklinknagel / Rivet
7. T-profiel / T-profile
7A. L-profiel / L-profile
8. Ventilatie / Ventilation
A. Alucopal®
B. Plastiflex® lijmbevestigingssysteem / Plastiflex® adhesive system

TAU
systeem gelijmd
adhesive system

DETAIL 108

Verticale doorsnede raam/gevel
Vertical window section

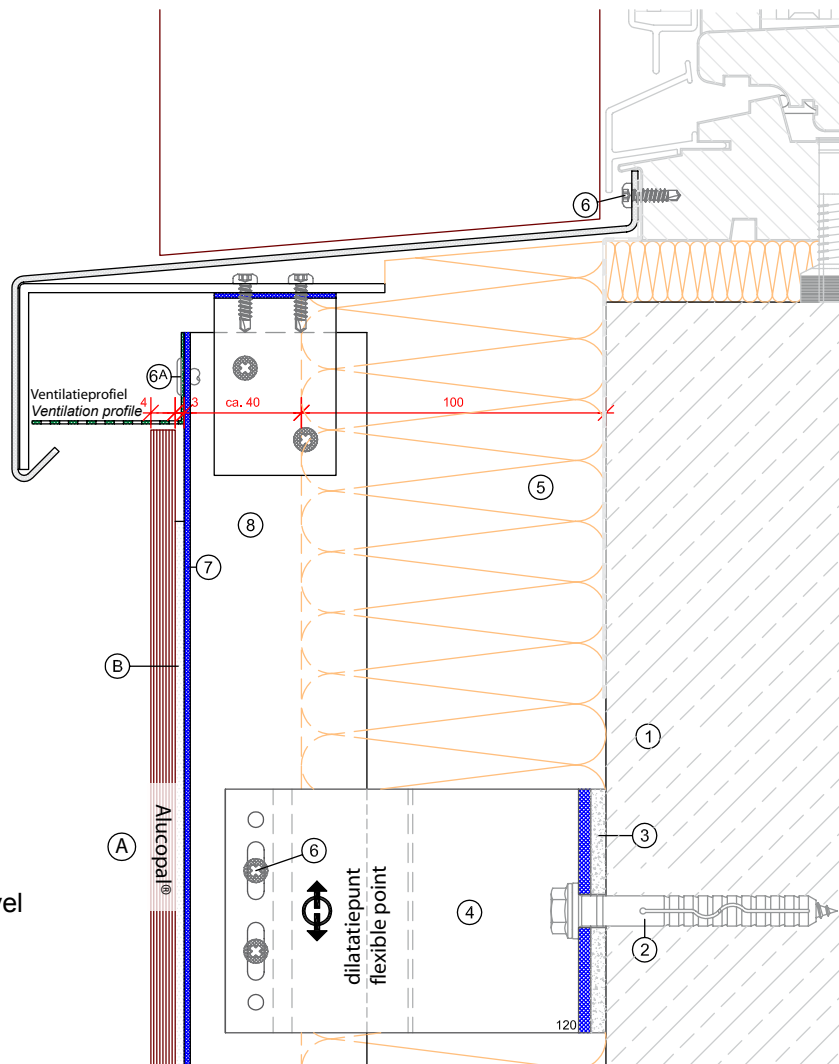

1. Wand / Wall
2. Plug / Dowel
3. Isolator / Isolator
4. Steun 120 / Bracket 120
5. Isolatie / Isolation
6. Zelfsnijdende schroef / self drilling screw
6A. Blindklinknagel / Rivet
7. T-profiel / T-profile
7A. L-profiel / L-profile
8. Ventilatie / Ventilation
A. Alucopal®
B. Plastiflex® lijmbevestigingssysteem / Plastiflex® adhesive system

TAU
systeem gelijmd
adhesive system

DETAIL 109

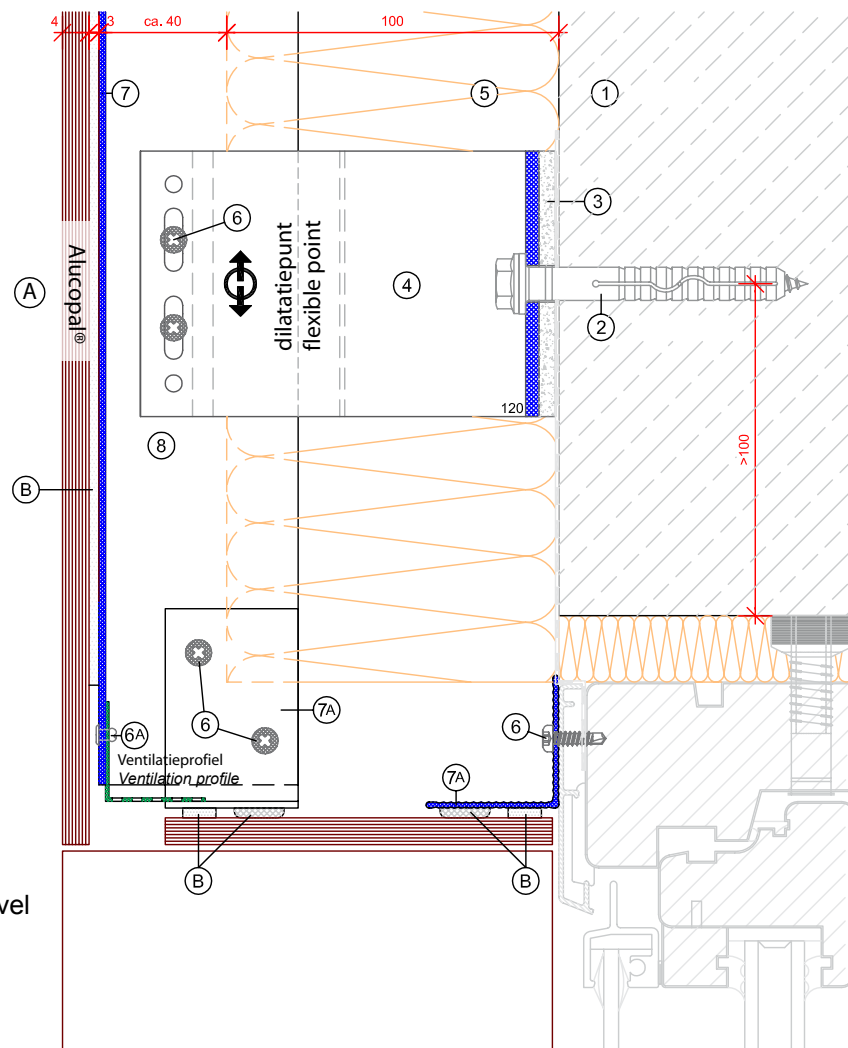

Verticale doorsnede raam/gevel
Vertical window section

1. Wand / Wall
2. Plug / Dowel
3. Isolator / Isolator
4. Steun 120 / Bracket 120
5. Isolatie / Isolation
6. Zelfsnijdende schroef / self drilling screw
6A. Blindklinknagel / Rivet
7. T-profiel / T-profile
7A. L-profiel / L-profile
8. Ventilatie / Ventilation
A. Alucopal®
B. Plastiflex® lijmbevestigingssysteem / Plastiflex® adhesive system

TAU
systeem gelijmd
adhesive system

DETAIL 109

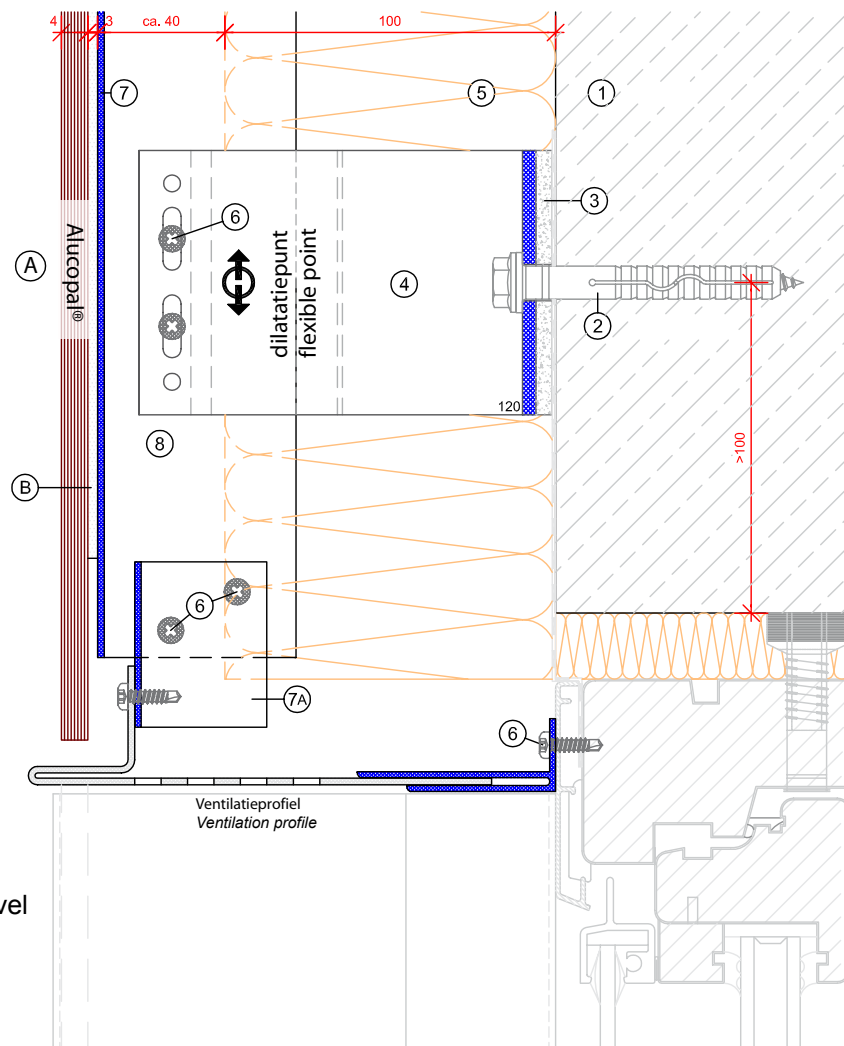

Verticale doorsnede raam/gevel
Vertical window section

1. Wand / Wall
2. Plug / Dowel
3. Isolator / Isolator
4. Steun 120 / Bracket 120
5. Isolatie / Isolation
6. Zelfslijdende schroef / self drilling screw
6A. Blindklinknagel / Rivet
7. T-profiel / T-profile
7A. L-profiel / L-profile
8. Ventilatie / Ventilation
A. Alucopal®
B. Plastiflex® lijmbevestigingssysteem / Plastiflex® adhesive system

TAU
systeem gelijmd
adhesive system

Verticale doorsnede raam/gevel
Vertical window section

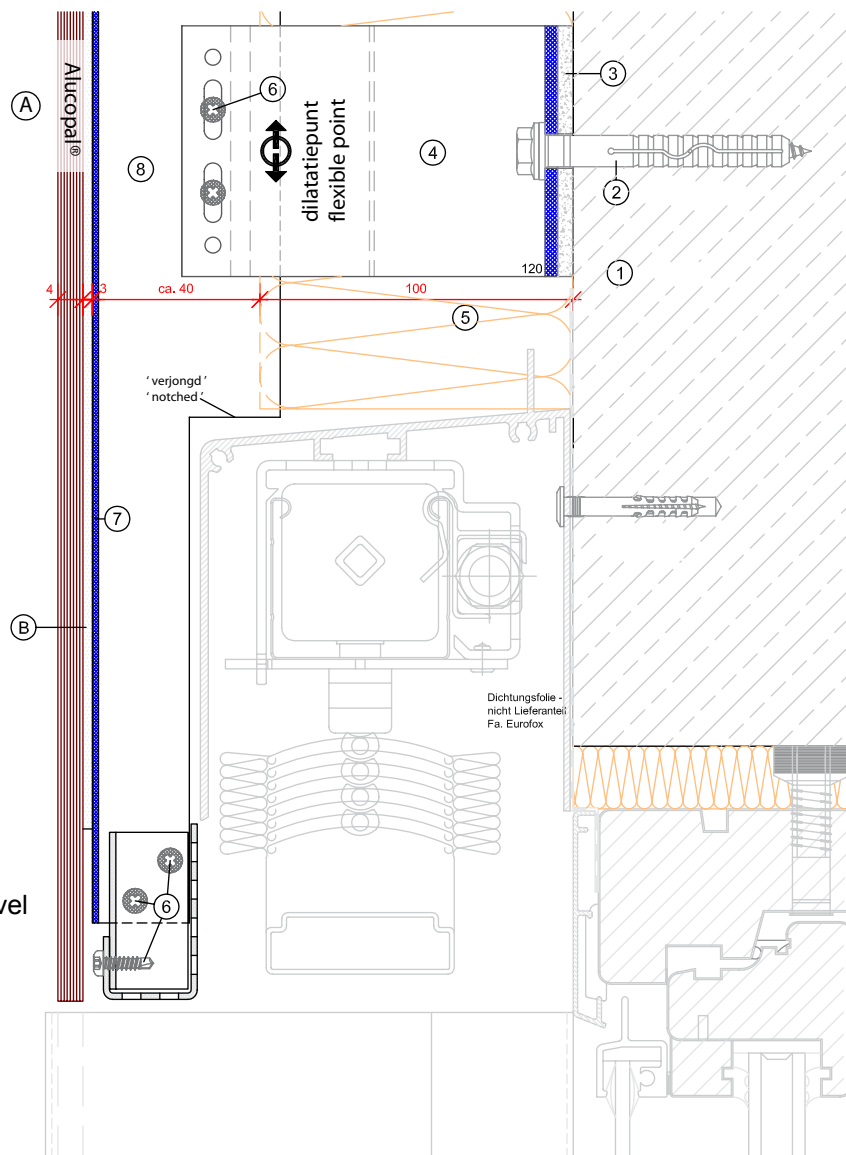

1. Wand / Wall
2. Plug / Dowel
3. Isolator / Isolator
4. Steun 120 / Bracket 120
5. Isolatie / Isolation
6. Zelfsnijdende schroef / self drilling screw
6A. Blindlinknagel / Rivet
7. T-profiel / T-profile
7A. L-profiel / L-profile
8. Ventilatie / Ventilation
A. Alucopal®
B. Plastiflex® lijmbevestigingssysteem / Plastiflex® adhesive system

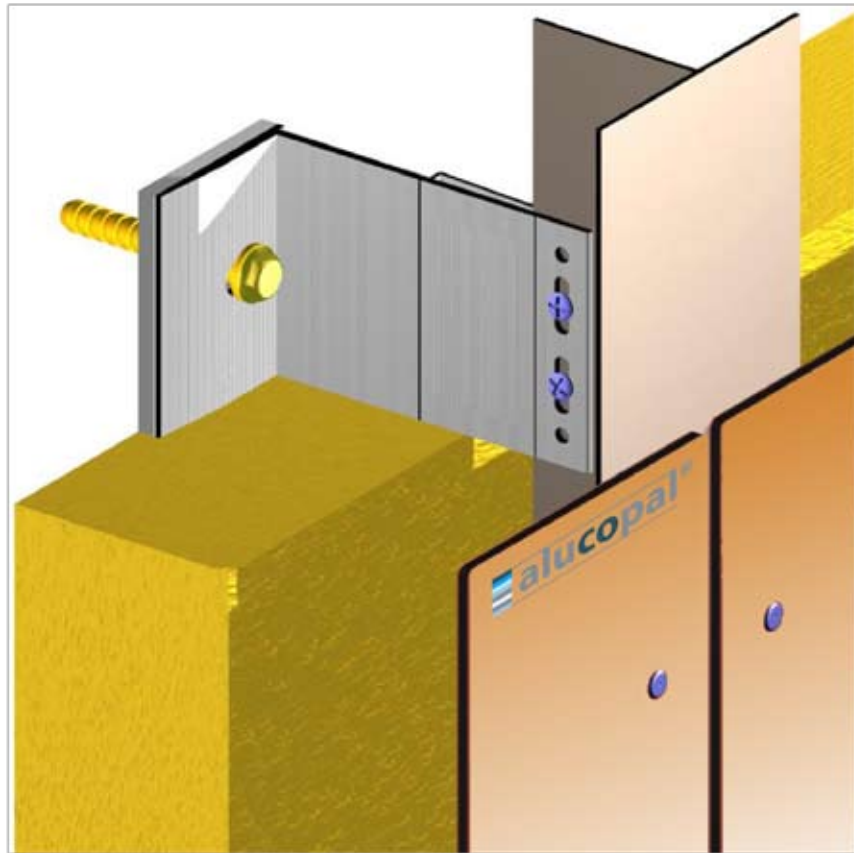

SystemTAU blindklinknagel

